

Dimensions

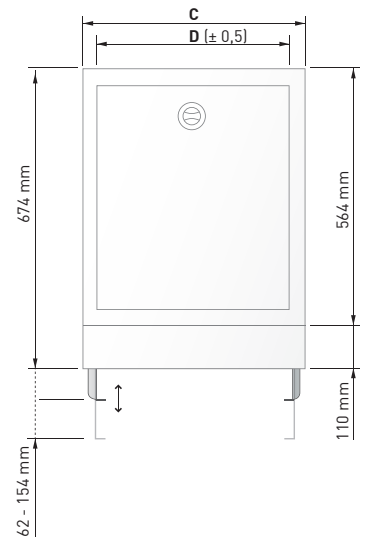

Manifold box type	VS1	VS2	VS3	VS4
A (mm)	385	574	874	1174
B (mm)	345	534	834	1134
C (mm)	409	598	898	1198
D (mm)	341	530	830	1130
Heating/cooling distribution manifold circuits	2-3	1, 4-6	7-12	13-17
PVST pumped manifold circuits	-	2-5	6-11	12-14
PMST microstation circuits	1-2	-	-	-

Wall bracket installation and variations

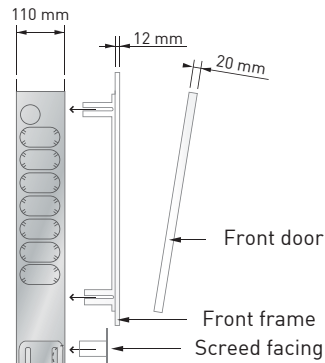
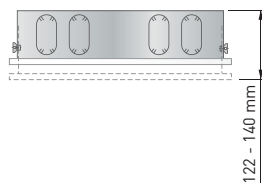
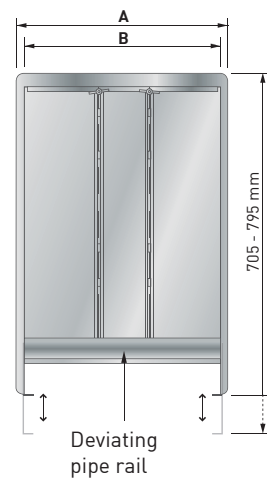
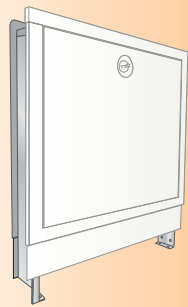
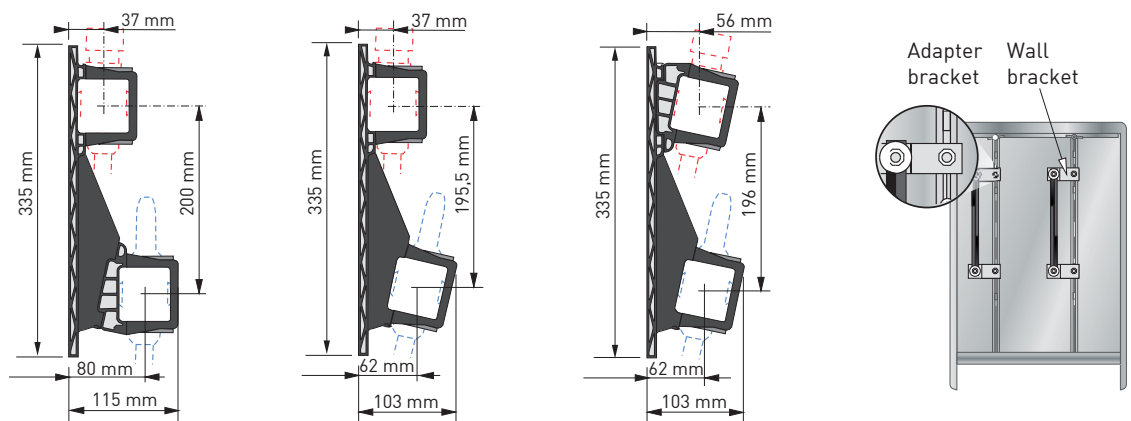

Installation

- 1 Remove the front frame and the base cover from the cabinet.
- 2 Place the cabinet in the recess in the wall, straighten it using the adjustable feet and fix it to the unfinished floor.
- 3 Screw the attached adapter bracket to the C rail and clamp the wall mounts of the heating/cooling distribution manifold underneath it. The wall mounts are positioned directly on the rear wall.
- 4 Attach the heating/cooling distribution manifold to the wall brackets.
- 5 Connect the connection pipes. To do so, pre-cut opening plates on the right and left can be broken open.
- 6 Fix the wall cabinet in the wall with quick setting cement. Screw it to the supporting structure in the drywall.
- 7 Lay out the heating/cooling distribution circuits. Feed the flow and return behind the deviating pipe bend into the floor and towards the heating surfaces.

In-wall mounted front frame:

8a Attach the screed facing (this will not be plastered over later) - this covers the area between the front frame and the finished floor level. Cover all visible parts well (e.g. with painter's tape) - protect the opening from dirt with card or plastic film.

9a After completing the wall, remove the protective coverings or adhesive tapes and attach the doors.

Wall-mounted front frame:

8b. Attach the screed facing (this will not be plastered over later) - this covers the area between the front frame and the finished floor level. Align the front box edge to the finished plaster edge or finished wall edge. Cover all visible parts well (e.g. with painter's tape) - protect the opening from dirt with card or plastic film.

9b. After completing the wall, remove the protective coverings or adhesive tapes and attach the front frames and doors.

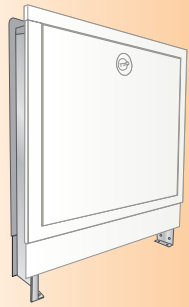

Example for in-wall mounted front frame

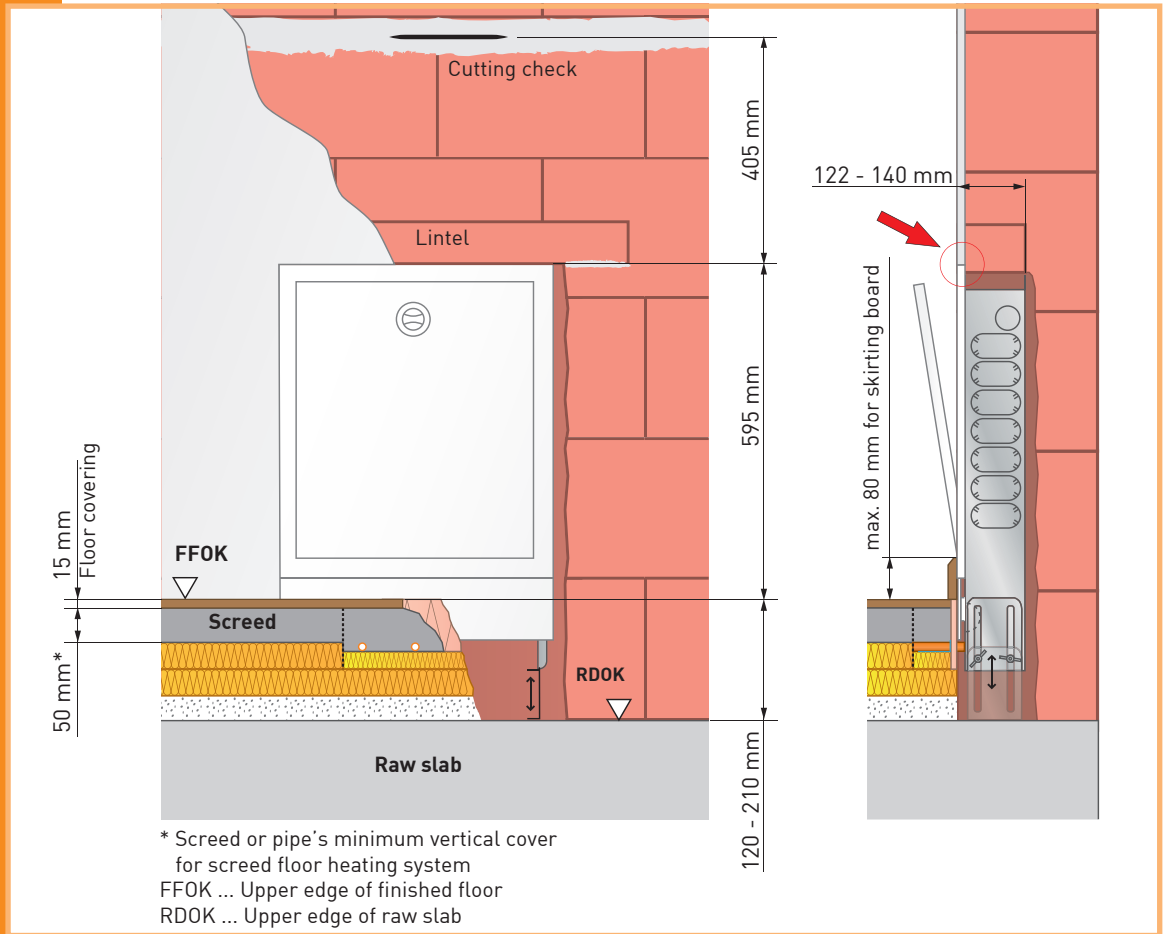

Example for wall-mounted front frame

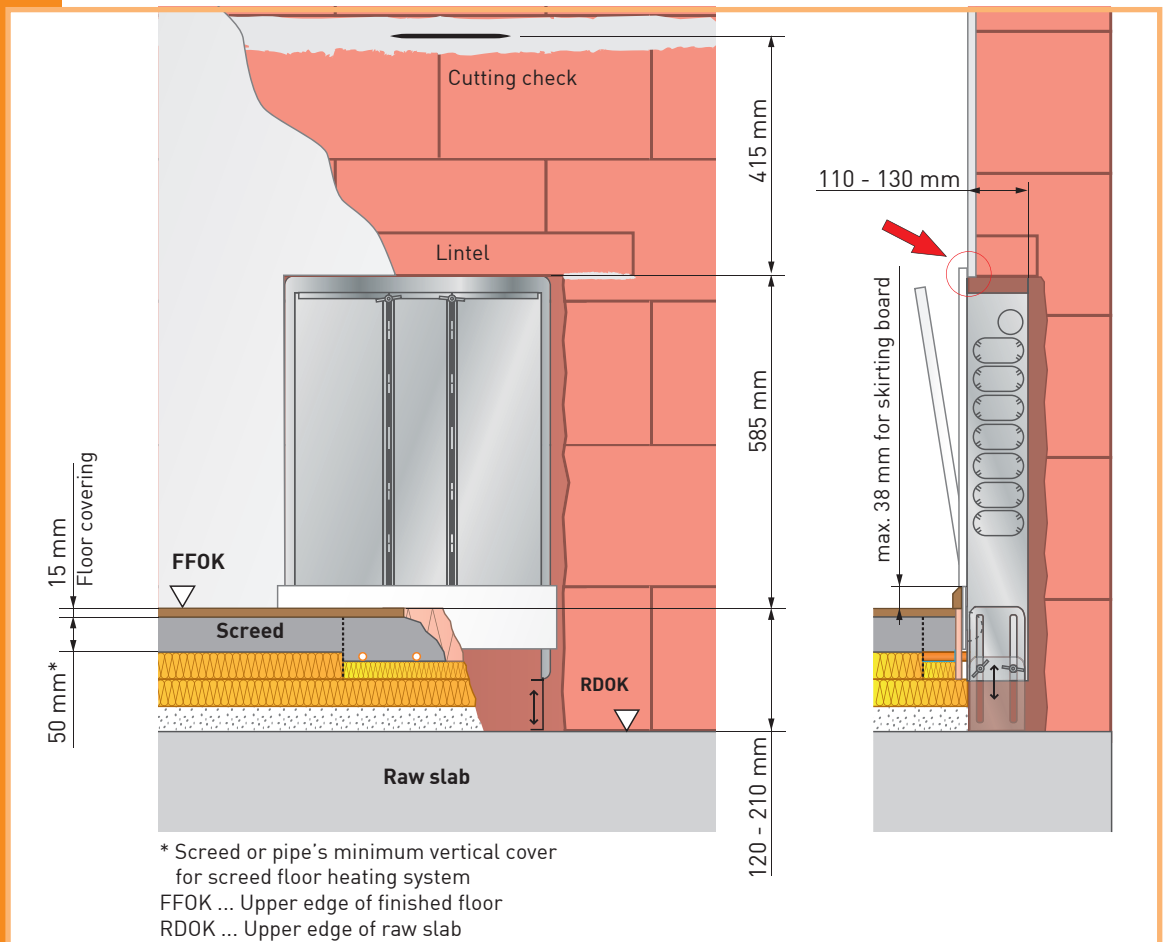

VARIOTHERM
 HEATING. COOLING. COMFORT.